

# ORIGAMI LP

Ultra-low noise femtosecond laser module



# Very compact with ultra-low phase noise and timing jitter

Ideal for high-precision industrial applications

The ORIGAMI is specifically designed for OEM integration.

This industrial-grade, ultra-compact, mode-locked, femtosecond laser provides the lowest phase noise and timing jitter on the market.



## Origami LP

---

### Applications

Clock distribution

Seed for amplifiers

Frequency comb systems

THz generation

Supercontinuum generation

Radar systems/Analog-to-

digital converters



# Reliable

## High power, clean pulses, and high repetition rate

The ORIGAMI families of laser emit transform-limited soliton pulses, providing diffraction-limited beam quality and excellent pointing stability. It is available at various wavelengths and repetition rates.

## Maintenance-free and OEM-ready

The ORIGAMI is an air-cooled, maintenance-free laser module packaged in a sealed and robust enclosure allowing for operation in the harshest environments.

No alignment is required, and it guarantees high stability, low drift, and 24/7 operation.

## Features

- Lowest phase noise on the market
- No Kelly sidebands or spectral ripple
- Diffraction-limited beam quality
- Shot noise-limited relative intensity noise (RIN)
- Transform-limited soliton pulses of outstanding cleanliness
- Plug and Play
- Maintenance-free 24/7 operation

## Pulse profile - Autocorrelation

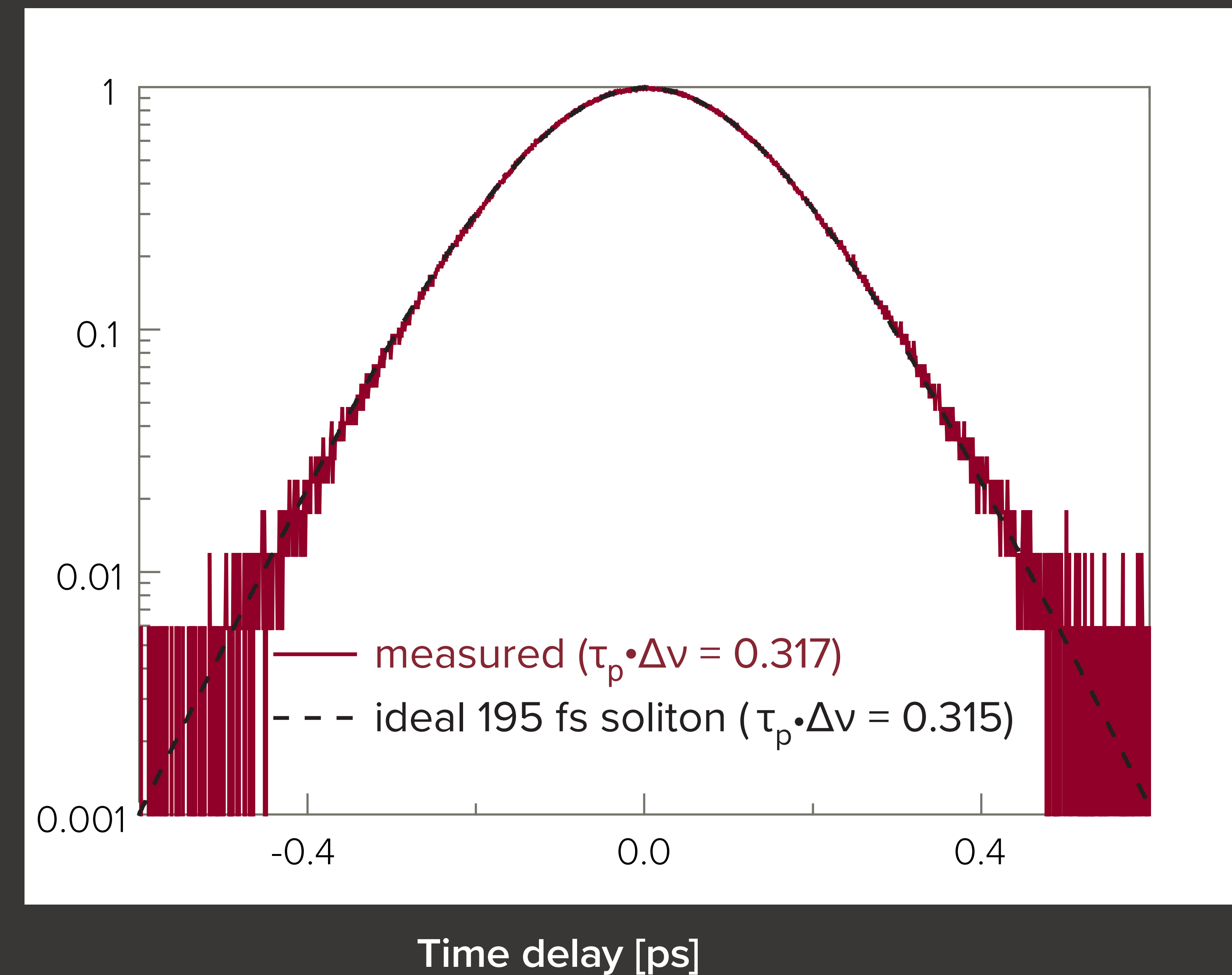

# Options

## **Flexible output and synchronization to external clock**

Depending on model, output options are collimated free-space or single mode fiber.

The ORIGAMI can also be synchronized to an external reference for ultra-low timing jitter.

## **A large variety of options with ORIGAMI accessories**

Whether you want ultra-low noise laser control or easy and simple synchronization, the range of ORIGAMI laser accessories gives you full variability.

The ultra low noise controller is a plug and play, add-on module to drive its mode-locked laser unit with the lowest possible timing jitter.

The compact and simple laser synchronization module allows the synchronization of pulsed laser trains to an external reference signal.

The ultra-low noise synchronization allows for synchronization of ultra-short laser pulse trains with femtosecond precision.

The Carrier Envelope Phase (CEP) ready system consists of advanced laser and electronic architecture which allows to control the CEP of the lasers in addition to the pulse repetition rate.

## **Options**

Sync (synchronization to external clock for ultra-low timing jitter)

Low noise driver

Carrier-Envelope-Phase (CEP) ready

Analog pump power control

Repetition rate control and tunability

Fiber output, armored PM or SM fiber



# Performance

Spectral power density [dBc/nm]

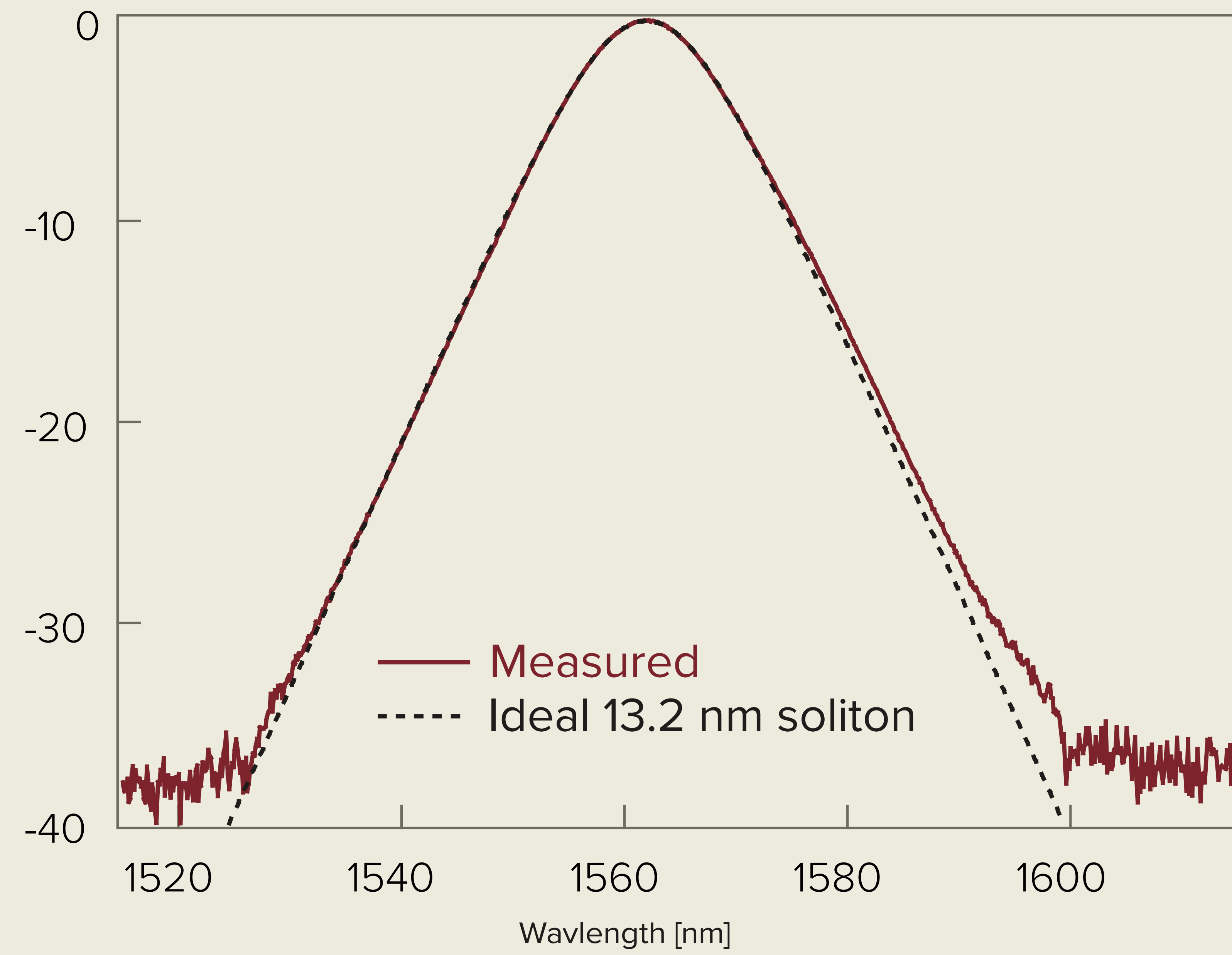

Optical spectrum as a function of time

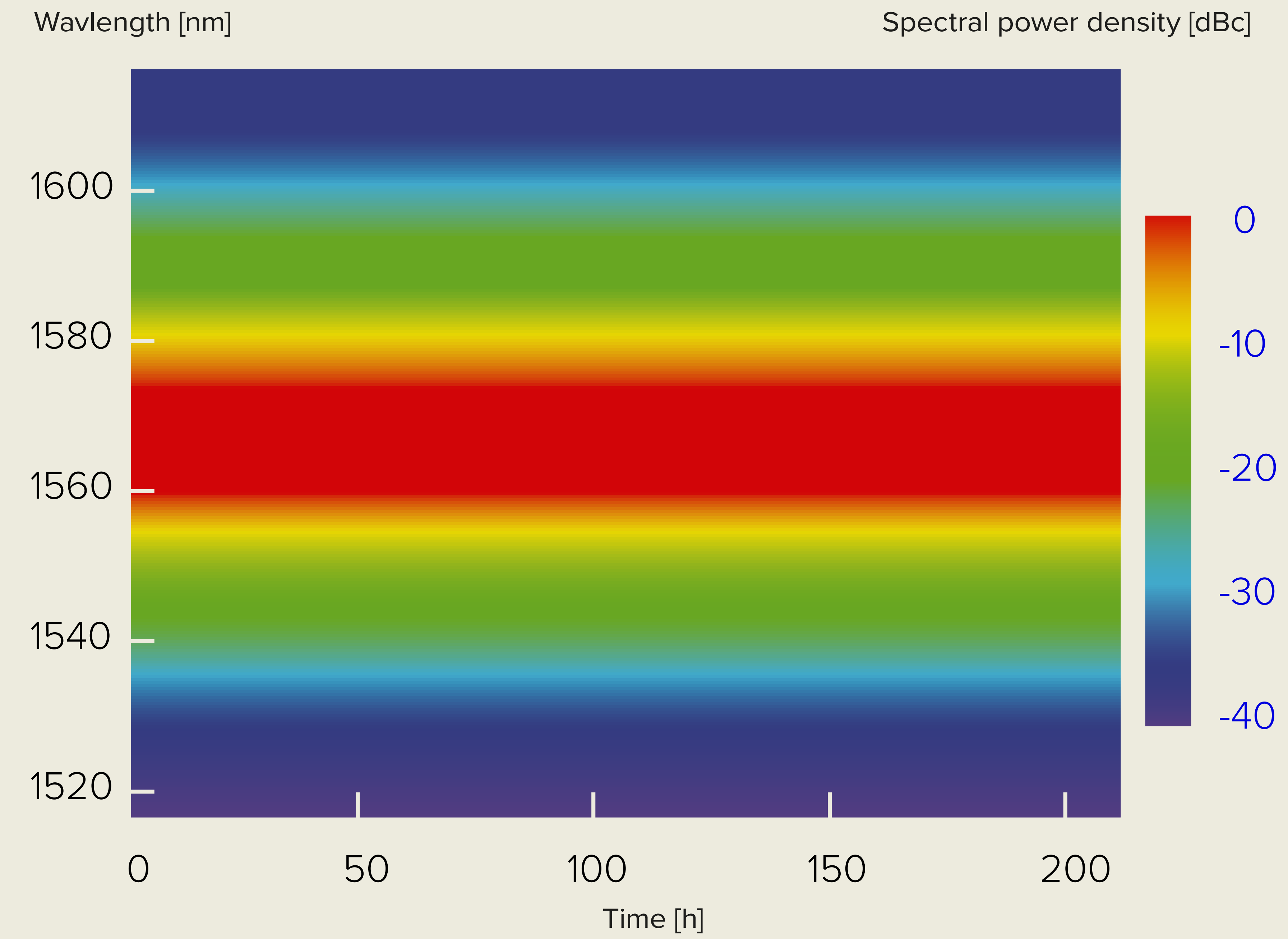



# Performance

## Temperature cycling

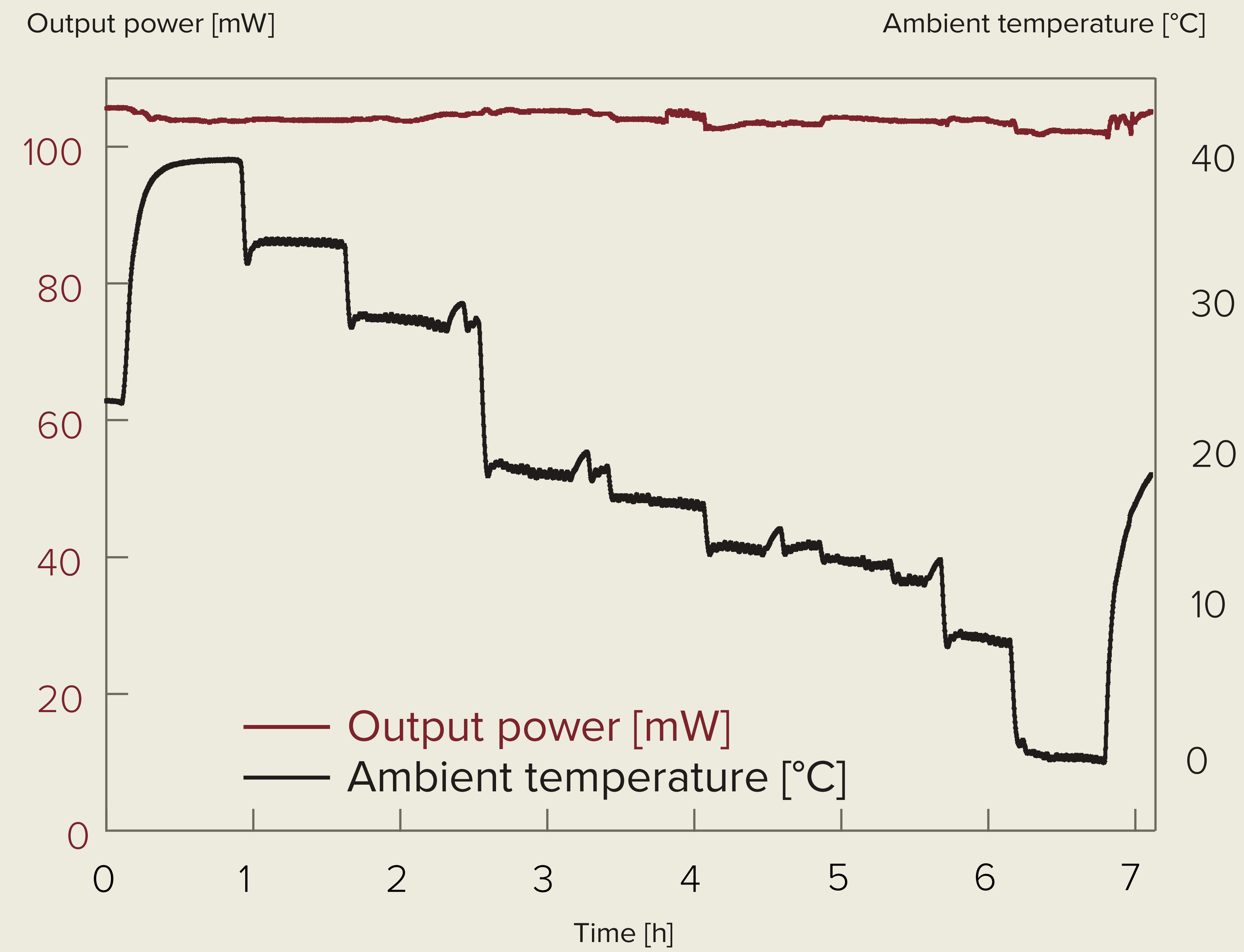

## Phase noise vs timing jitter

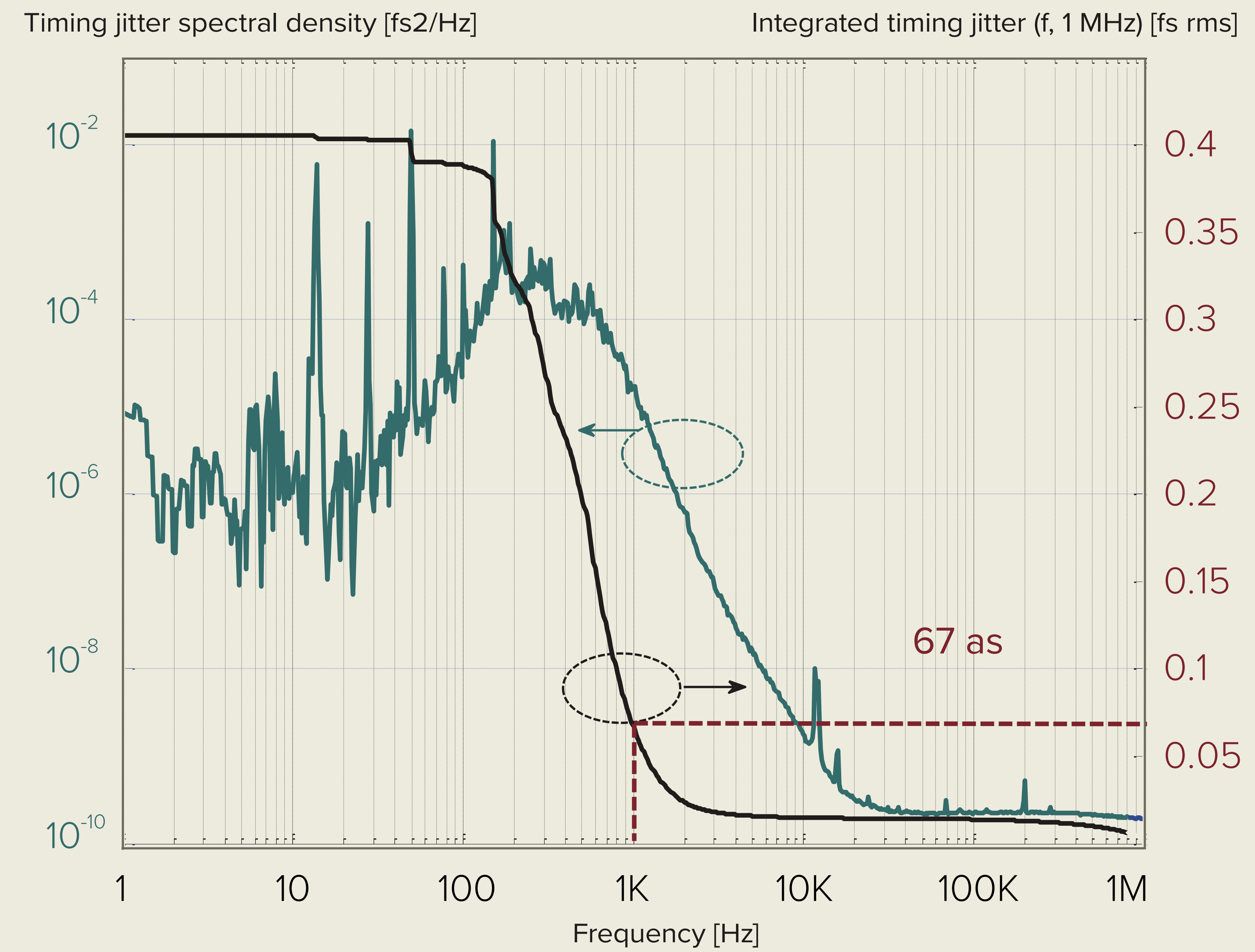

Reference: Peng et al, "Long-term Stable, large-scale, Optical Timing Distributing Systems with Sub-Femtosecond Timing Stability" Proceedings of FEL2013, New York



# Specifications - Single Output



## Optical

Model	05-40	08-50	10-40	10-80	10-100	15-80	15-100
Repetition rate [MHz]	40 ± 2	50 ± 2	40 ± 2	80 ± 2	100 ± 2	80 ± 2	100 ± 2
Center wavelength [nm]	515 ± 3	780 ± 5	1030 ± 2	1030 ± 2	1030 ± 2	1560 ± 5	1560 ± 10
Pulse duration [fs]	< 180	< 160	< 200	< 200	< 200	< 200	< 100
Average power [mW]	> 25	> 20	> 100	> 160	> 200	> 120	> 100 <sup>2</sup>
Pulse energy [nJ]	> 0.625	> 0.4	> 2.5	> 2	> 2	> 1.5	> 1
Peak power [kW]	> 2	> 2	> 10	> 8	> 8	> 6	> 8
Spectral bandwidth [nm]	Transformlimited ( $\tau_p \cdot \Delta\nu \sim 0.32$ )	Transformlimited ( $\tau_p \cdot \Delta\nu \sim 0.32$ )	Transformlimited ( $\tau_p \cdot \Delta\nu \sim 0.32$ )	Transformlimited ( $\tau_p \cdot \Delta\nu \sim 0.32$ )	Transformlimited ( $\tau_p \cdot \Delta\nu \sim 0.32$ )	Transformlimited ( $\tau_p \cdot \Delta\nu \sim 0.32$ )	N.A.
Beam quality (TEM <sub>00</sub> )	$M^2 \leq 1.4$	$M^2 \leq 1.2$	$M^2 \leq 1.1$	$M^2 \leq 1.1$	$M^2 \leq 1.1$	$M^2 \leq 1.1$	$M^2 \leq 1.1$
Polarization / PER (vertical) [dB]	> 23	> 23	> 23	> 23	> 23	> 18	> 18
Amplitude noise [%]	< 0.2% RMS, < 0.5% pk-pk (24h)						
Timing jitter (1kHz - 10 MHz) [fs]	< 30	< 50	< 30	< 30	< 30	< 30	< 30
Laser output	Collimated free-space	Collimated free-space	Collimated free-space	Collimated free-space	Collimated free-space	Collimated free-space	PM fiber, FC/APC <sup>3</sup>

<sup>1</sup> Please inquire for possible combinations of wavelength, pulse duration, average power, pulse energy, and repetition rate.

<sup>2</sup> Exclusive fiber.

<sup>3</sup> Armored single-mode fiber, <sup>20</sup> or <sup>50</sup> cm (other lengths are available).



# Specifications - Single Output

**Origami**  
LP

## Electrical/Mechanical

<b>Warm-up time [min.]</b>	< 10	
<b>Operation temperature [°C]</b>	10 – 40	
<b>Storage temperature [°C]</b>	-20 – 55	
<b>Power supply requirements</b>	24 VDC/2.5 A or 90-264 VAC, 47-63 Hz	
<b>Power consumption [W]</b>	< 15	
<b>Laser head dimensions (WxHxD) [mm]</b>	08-50:	257 x 54 x 189
	10-40:	250 x 54 x 200
	15-80/15-100:	296 x 54 x 112
<b>Laser head weight [kg] <sup>4</sup></b>	2.5	
<b>Laser head cooling</b>	Air	
<b>Control unit dimensions (WxHxL) [mm<sup>3</sup>]</b>	104 x 44 x 165	
<b>Control unit weight [kg]</b>	0.65 kg	
<b>Control unit cooling</b>	Air	

<sup>4</sup> Exact size and weight depends on the model.

---

## Support and warranty

All ORIGAMI products come with an industry leading reliability.

The product is covered by a comprehensive warranty. Service options are available. For details, please enquire.



# Technical Drawings

## ORIGAMI 08-50

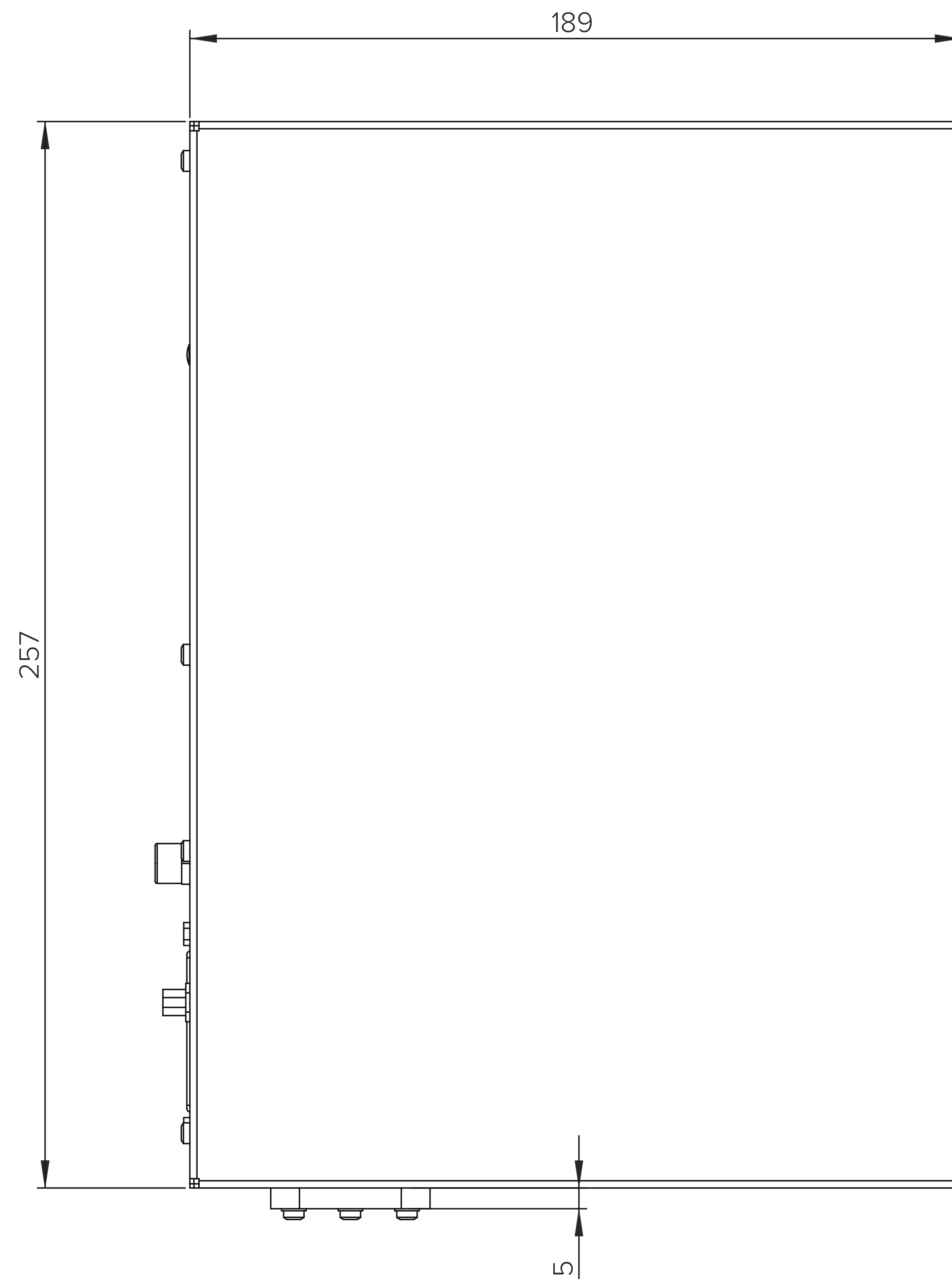
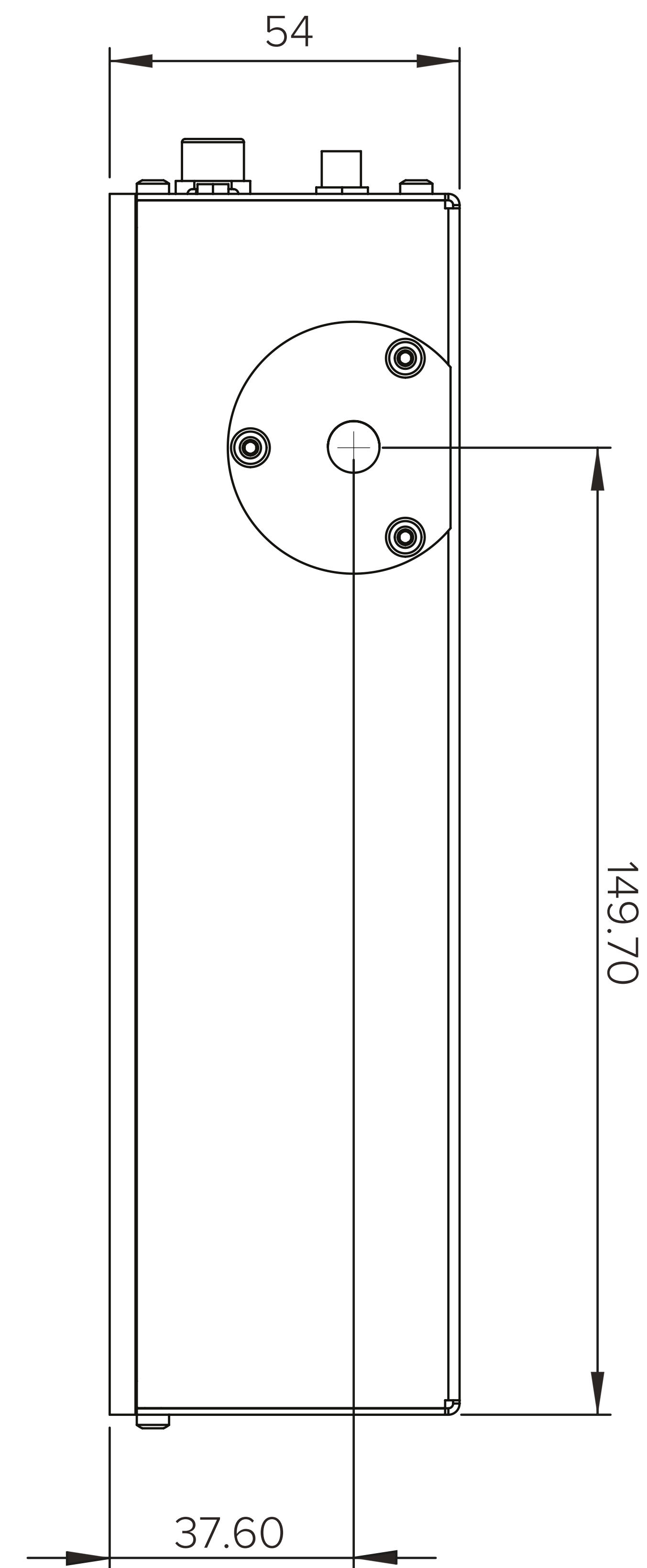

## Origami LP

All ORIGAMI products are produced under our quality management system certified in accordance with the ISO 9001:2015 and ISO 13485:2016 standard.





# Technical Drawings

## ORIGAMI 10-40

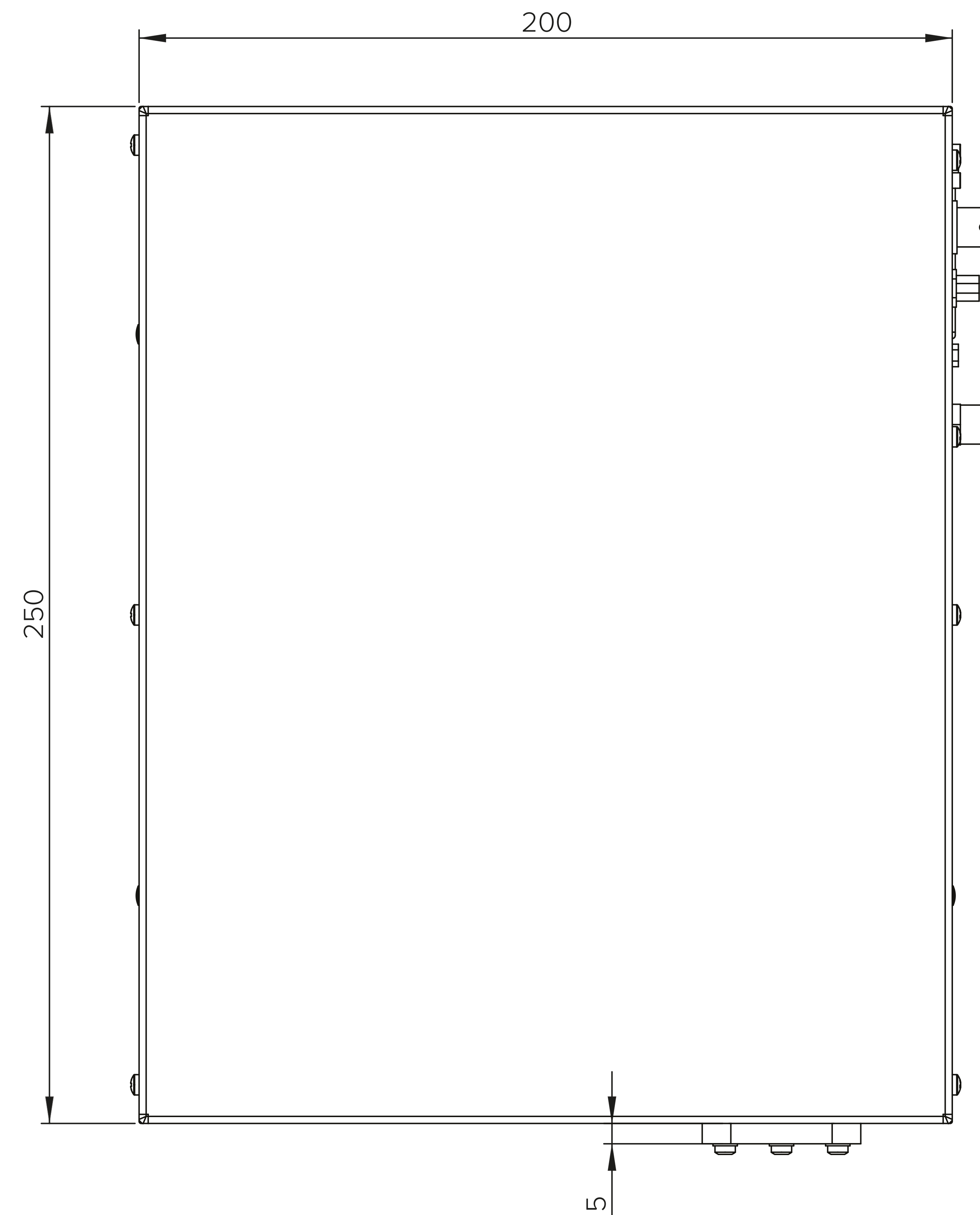
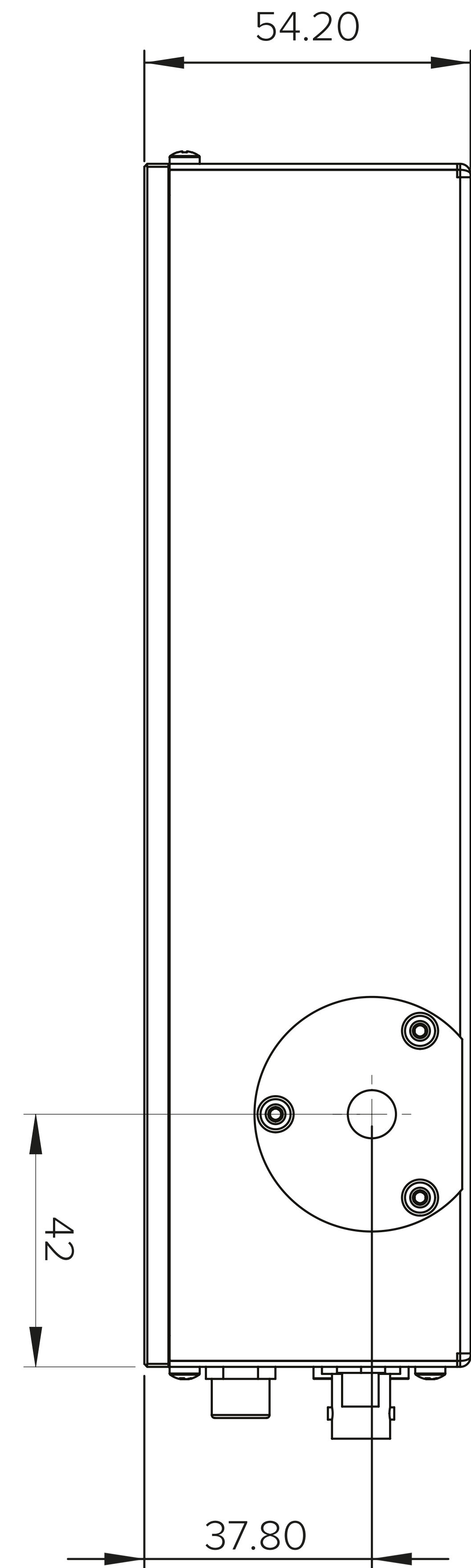

# Origami LP

All ORIGAMI products are produced under our quality management system certified in accordance with the ISO 9001:2015 and ISO 13485:2016 standard.





# Technical Drawings

## ORIGAMI 15-80 / 15-100

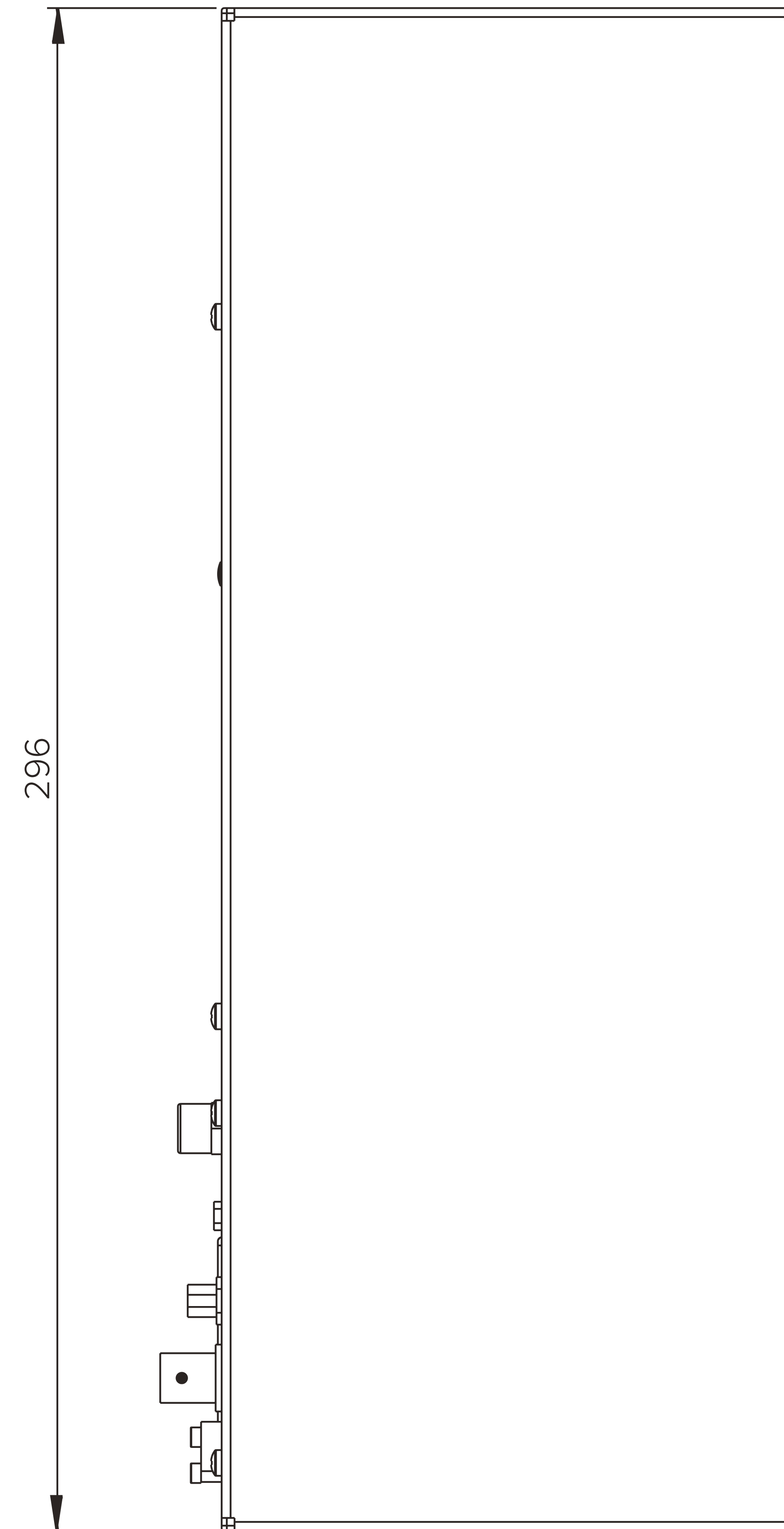

## Origami LP

All ORIGAMI products are produced under our quality management system certified in accordance with the ISO 9001:2015 and ISO 13485:2016 standard.





# SOLUTIONS FOR INNOVATORS